



HERSCHEL Krystal Ceiling Surround Mount

INSTALLATION INSTRUCTIONS

EN INSTALLATION INSTRUCTIONS
FR INSTRUCTIONS D'INSTALLATION
NL INSTALLATIE INSTRUCTIES
DE INSTALLATIONS ANLEITUNG
IT ISTRUZIONI PER L'INSTALLAZIONE
ES INSTRUCCIONES DE INSTALACIÓN

PANELS COVERED BY THESE INSTRUCTIONS:

Black Panels	White Panels	Power
Krystal-600-B	Krystal-600-W	600W, 220 – 240V, 50/60Hz
Krystal-1000-B	Krystal-1000-W	1000W, 220 – 240V, 50/60Hz

Ceiling Mounting using brackets and surround mounting kit.

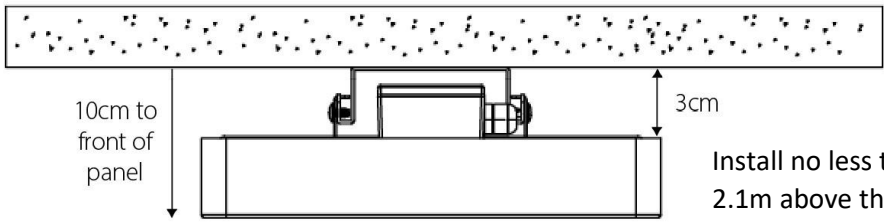

Hardware Includes:

Small self-tapping screws x 12



Heater Bracket x 2

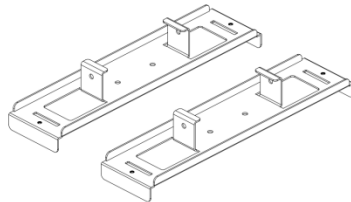

Rawlplugs x 4

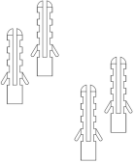

PWA Tapping screws x 4

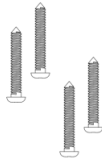

Ceiling Bracket x 1

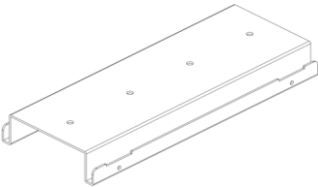

Heater Surround x 1

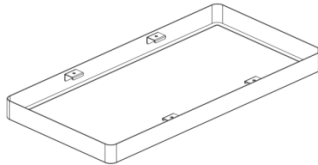

Steps:

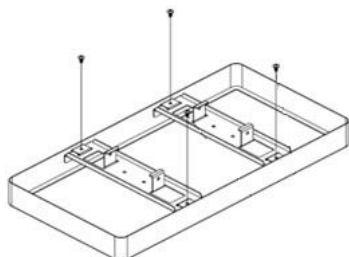

1. Attach the heater brackets to the surround and secure with 4 x small self-tapping screws.

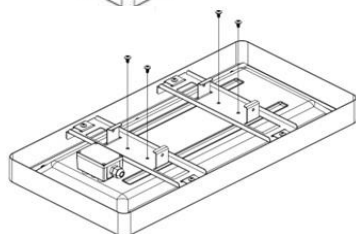

2. Attach the heater surround to the heater using 4 x small self-tapping screws as shown.

3. Mark the position of the 4 drill holes in the ceiling using the Ceiling brackets as a template.

4. Drill the 4 holes and insert the rawlplugs. Screw 4 x PWA Tapping Screws through the ceiling bracket and into the 4 rawlplugs to secure the bracket to the ceiling.

5. Slide the assembled heater and brackets onto the ceiling bracket until it settles into the two recesses in the middle of the bracket (see diagram). This will ensure the heater cannot then slide on the bracket.

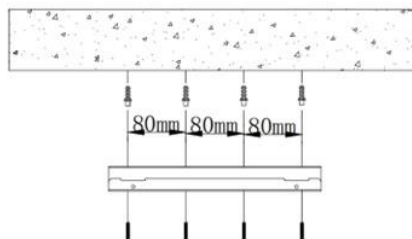
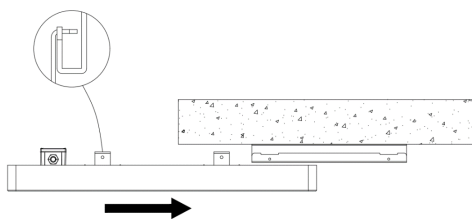

6. Use 4 x small self-tapping screws to fix the heater assembly onto the ceiling bracket.

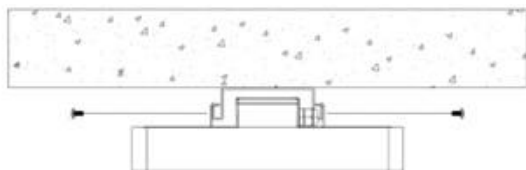

PANNEAUX COUVERTS PAR CES INSTRUCTIONS:

Panneaux noirs	Panneaux blancs	Puissance
Krystal-600-B	Krystal-600-W	600W, 220 – 240V, 50/60Hz
Krystal-1000-B	Krystal-1000-W	1000W, 220 – 240V, 50/60Hz

Montage au plafond à l'aide de kit de supports et du cadre.

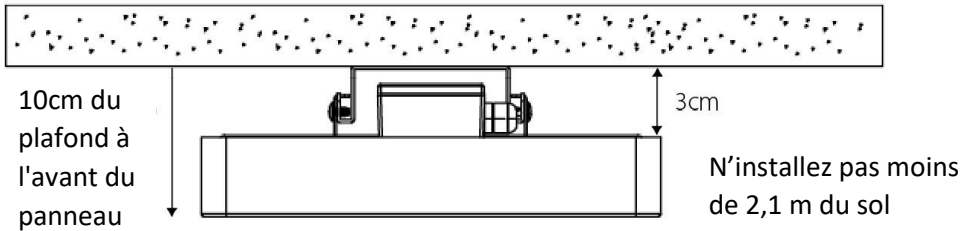

Matériaux inclus:

Petites vis autotaraudeuses x 12



Support de l'élément chauffant x 2

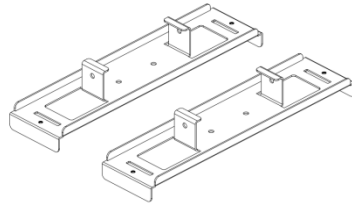

Bouchons de recharge x 4

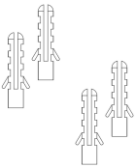

Vis à tôle PWA x 4

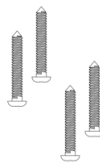

Support de plafond x 1

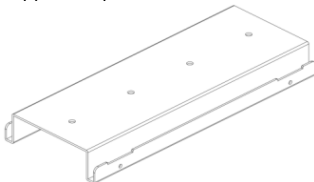

Entourage de l'appareil de chauffage x 1

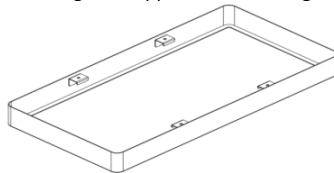

Etapes:

1. Fixez les supports de l'appareil de chauffage à l'entourage et fixez-les avec 4 petites vis autotaraudeuses.

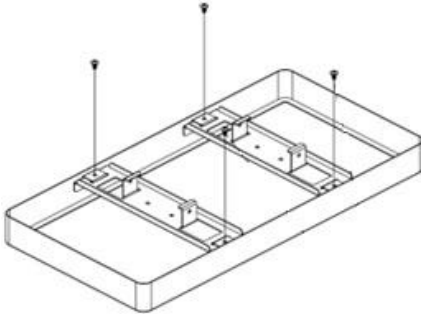

2. Fixez le cadre de l'appareil de chauffage à l'appareil de chauffage à l'aide de 4 petites vis autotaraudeuses, comme indiqué.

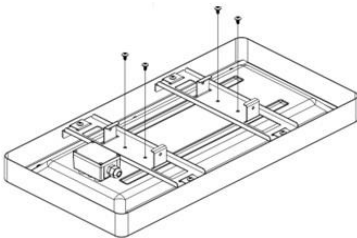

3. Marquez la position des 4 trous de perçage dans le plafond en utilisant les supports de plafond comme modèle.

4. Percez les 4 trous et insérez les chevilles. Vissez 4 vis à tête PWA à travers le support de plafond et dans les 4 chevilles pour fixer le support au plafond.

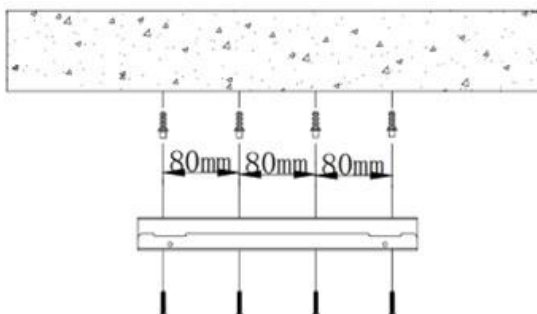

5. Faites glisser le radiateur et les supports assemblés sur le support de plafond jusqu'à ce qu'il s'installe dans les deux évidements au milieu du support (voir le schéma). Ainsi, le radiateur ne pourra pas glisser sur le support.

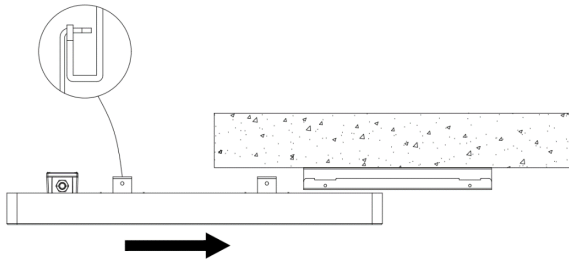

6. Utilisez 4 petites vis autotaraudeuses pour fixer l'ensemble du radiateur sur le support de plafond.

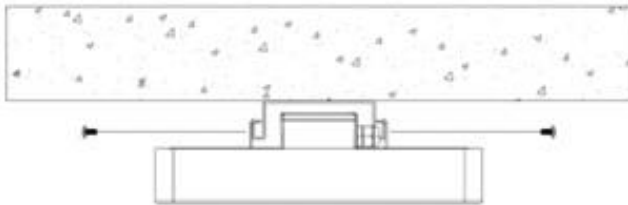

PANELEN WAAROP DEZE INSTRUCTIES BETREKKING HEBBEN:

Zwarte panelen	Witte panelen	Stroom
Krystal-600-B	Krystal-600-W	600W, 220 – 240V, 50/60Hz
Krystal-1000-B	Krystal-1000-W	1000W, 220 – 240V, 50/60Hz

Plafondmontage met behulp van beugels en een frame.

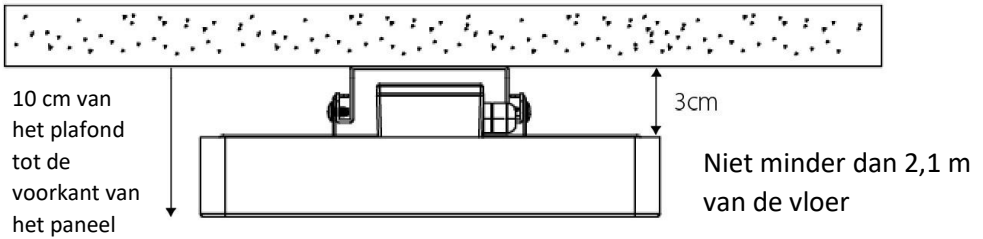

Inbegrepen hardware:

Kleine zelftappende schroeven x 12



Kachelbeugel x 2

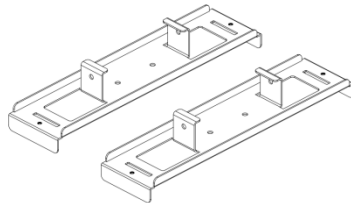

Reservepluggen x 4

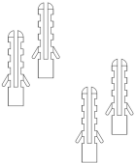

PWA-plaatschroeven x 4

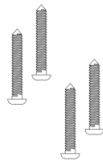

Plafondbeugel x 1

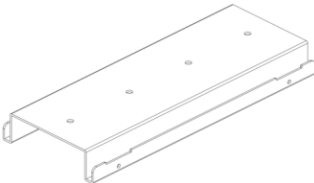

Rand verwarming x 1

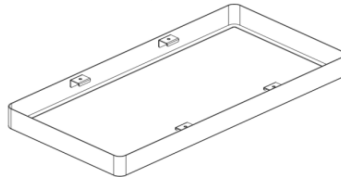

Stappen:

1. Bevestig de verwarmingsbeugels aan de verwarmingsrand en zet ze vast met 4 kleine zelftappende schroeven.

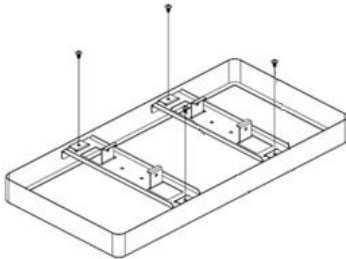

2. Bevestig het heaterframe aan de heater met 4 kleine zelftappende schroeven zoals afgebeeld.

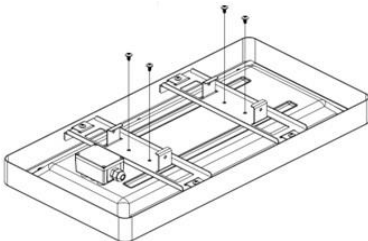

3. Markeer de positie van de 4 boorgaten in het plafond met behulp van de plafondbeugels als sjabloon.
4. Boor de 4 gaten en plaats de pluggen. Schroef 4 x PWA-tapschroeven door de plafondbeugel en in de 4 pluggen om de beugel aan het plafond te bevestigen.

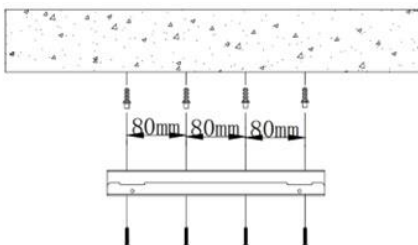

5. Schuif het geassembleerde verwarmingselemente radiator en de gemonteerde beugels op de plafondbeugel totdat het zicht tot hij in de twee uitsparingen in het midden van de beugel bevindtpast (zie diagram). Zo kan het verwarmingselement niet over de beugel schuiven. Dit voorkomt dat de radiator van de beugel glijdt.

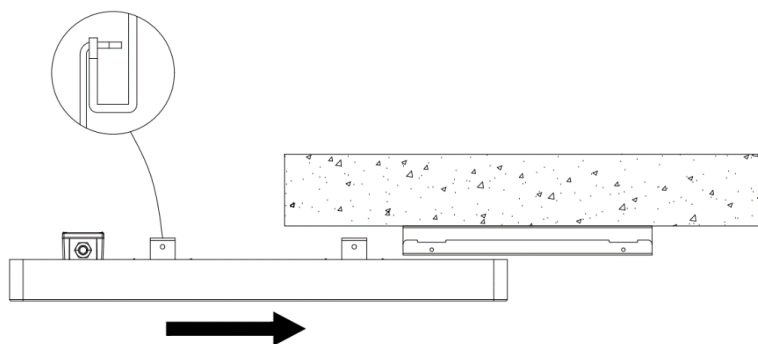

6. Gebruik 4 x kleine zelftappende schroeven om het verwarmingselementde radiator aan de plafondbeugel te bevestigen.

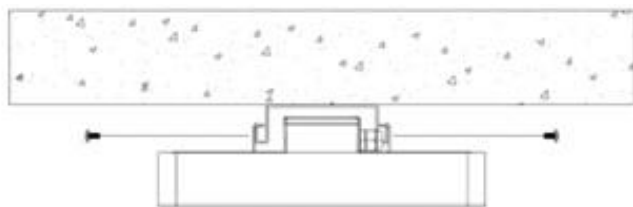

PANEELE, DIE VON DIESER ANLEITUNG ERFASST WERDEN:

Schwarze Paneele	Weiße Paneele	Leistung
Krystal-600-B	Krystal-600-W	600W, 220 – 240V, 50/60Hz
Krystal-1000-B	Krystal-1000-W	1000W, 220 – 240V, 50/60Hz

Deckenmontage mit Halterungen und Verkleidung.

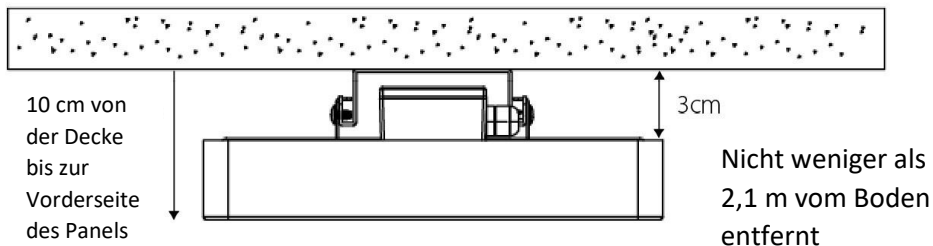

Inklusive Hardware:

Kleine selbstschneidende Schrauben x 12



Heizungshalterung (2 Stück)

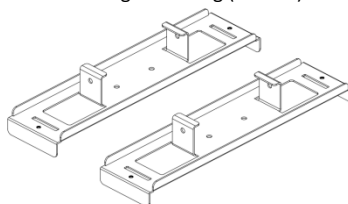

Dübel x 4

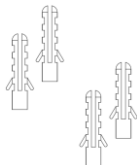

PWA-Schneidschrauben x 4

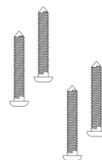

Deckenhalterung x 1

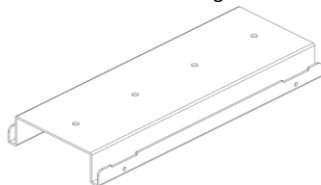

Heizungsumrandung x 1

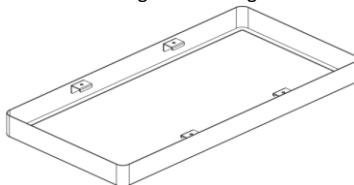

Schritte:

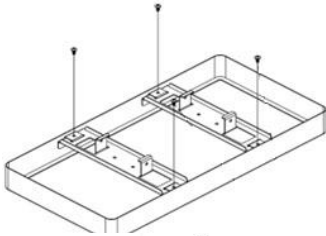

1. Bringen Sie die Heizungshalterungen an der Verkleidung an und befestigen Sie sie mit 4 kleinen selbstschneidenden Schrauben.

2. Befestigen Sie die Heizungshalterung an der Verkleidung mit 4 kleinen selbstschneidenden Schrauben wie abgebildet.

3. Markieren Sie die Position der 4 Bohrlöcher in der Decke, indem Sie die Deckenhalterungen als Schablone verwenden

4. Bohren Sie die 4 Löcher und setzen Sie die Dübel ein. Schrauben Sie 4 x PWA-Schneidschrauben durch die Deckenhalterung und in die 4 Dübel, um die Halterung an der Decke zu befestigen.

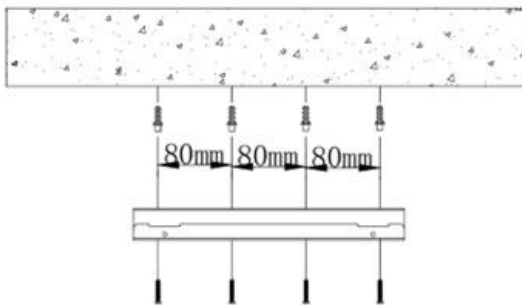
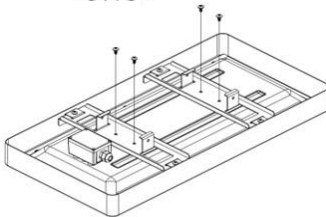

5. Schieben Sie die montierte Heizung und die Halterungen auf die Deckenhalterung, bis sie sich in den beiden Aussparungen in der Mitte der Halterung absetzt (siehe Diagramm). Dadurch wird sichergestellt, dass die Heizung dann nicht auf die Halterung gleiten kann.

6. Verwenden Sie 4 x kleine selbstschneidende Schrauben, um das Heizgerät an der Deckenhalterung zu befestigen.

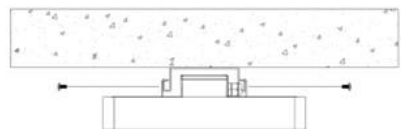
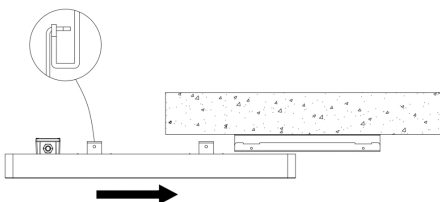

PANELS COVERED BY THESE INSTRUCTIONS:

Pannelli neri
 Krystal-600-B
 Krystal-1000-B

Pannelli Bianchi
 Krystal-600-W
 Krystal-1000-W

Potenza
 600W, 220 – 240V, 50/60Hz
 1000W, 220 – 240V, 50/60Hz

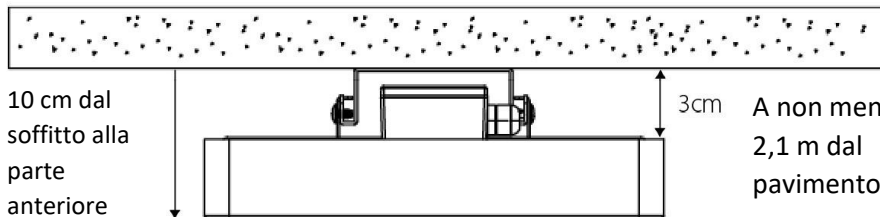

10 cm dal soffitto alla parte anteriore del pannello

3cm A non meno di 2,1 m dal pavimento.

La ferramenta comprende:

Viti autofilettanti piccole x 12



Staffa del riscaldatore x 2

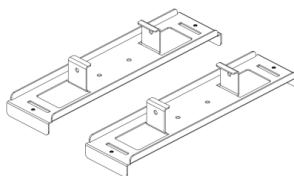

Tappi Rawlplugs x 4

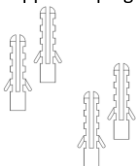

Viti autofilettanti PWA x 4

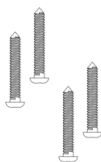

Staffa a soffitto x 1

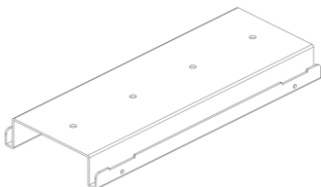

Circondario del riscaldatore x 1

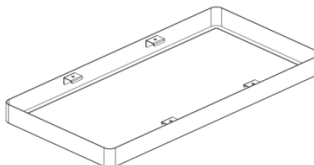

Passi:

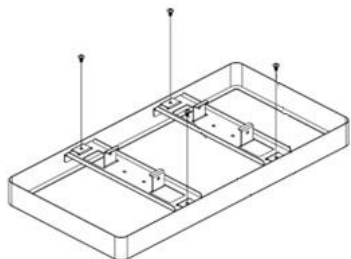

1. Fissare le staffe del riscaldatore alla cornice e fissarle con 4 piccole viti autofilettanti.

2. Fissare la cornice del riscaldatore al riscaldatore utilizzando 4 piccole viti autofilettanti come illustrato.

3. Segnare la posizione dei 4 fori nel soffitto utilizzando le staffe del soffitto come modello.

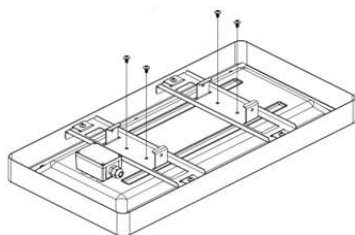

4. Praticare i 4 fori e inserire i tasselli. Avvitare 4 viti autofilettanti PWA attraverso la staffa a soffitto e nei 4 tasselli per fissare la staffa al soffitto.

5. Far scorrere il riscaldatore e le staffe assemblate sulla staffa del soffitto fino a quando non si posiziona nelle due rientranze al centro della staffa (vedere la figura). In questo modo il riscaldatore non potrà scivolare sulla staffa.

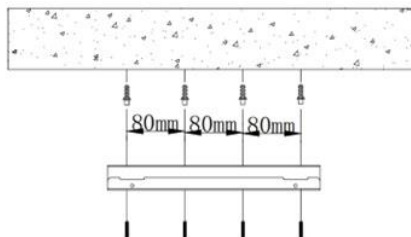
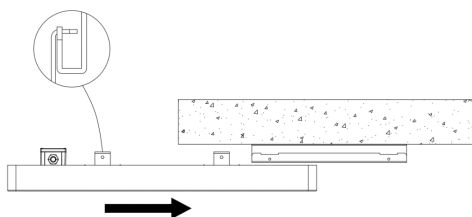

6. Utilizzare 4 piccole viti autofilettanti per fissare il gruppo riscaldatore alla staffa a soffitto.

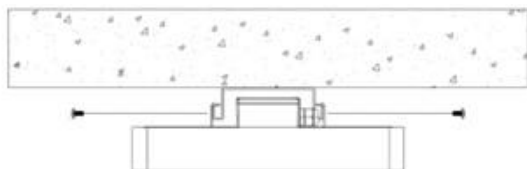

PANELES CUBIERTOS POR ESTAS INSTRUCCIONES:

Paneles negros	Paneles blancos	Potencia
Krystal-600-B	Krystal-600-W	600W, 220 – 240V, 50/60Hz
Krystal-1000-B	Krystal-1000-W	1000W, 220 – 240V, 50/60Hz

Montaje en el techo con soportes y marco.

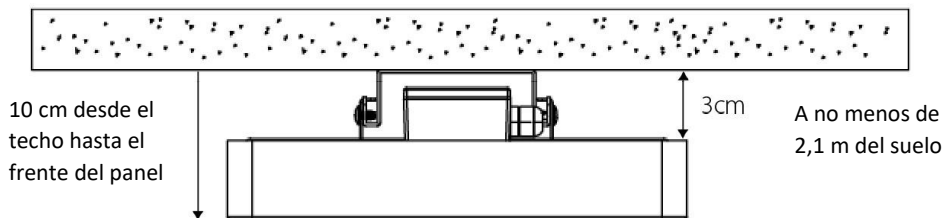

El hardware incluye:

Pequeños tornillos autorroscantes x 12



Soporte del calentador x 2

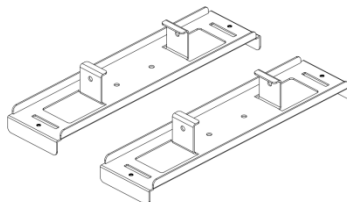

Tapones x 4

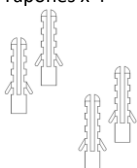

Tornillos autorroscantes PWA x 4

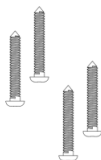

Soporte de techo x 1

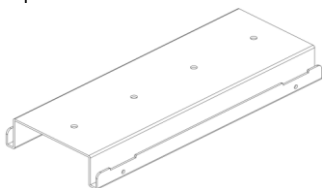

Envolvente del calentador x 1

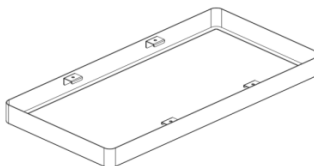

Escalones:

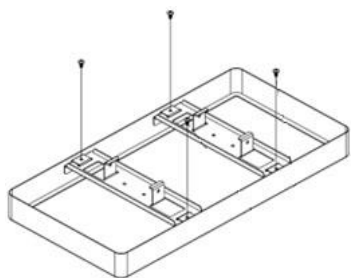

1. Coloque los soportes del calefactor en el marco y fíjelos con 4 tornillos autorroscantes pequeños.

2. Fije el marco del calefactor al calefactor con 4 tornillos autorroscantes pequeños, tal como se muestra.

3. Marque la posición de los 4 agujeros de perforación en el techo utilizando los soportes del techo como plantilla.

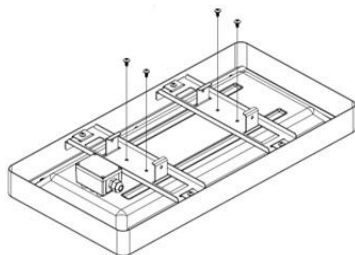

4. Taladre los 4 agujeros e inserte los tapones. Atornille 4 tornillos autorroscantes PWA a través del soporte de techo y en los 4 tapones para fijar el soporte al techo.

5. Deslice el calefactor ensamblado y los soportes en el soporte de techo hasta que se asiente en los dos huecos del centro del soporte (véase el diagrama). Esto asegurará que el calefactor no pueda deslizarse sobre el soporte.

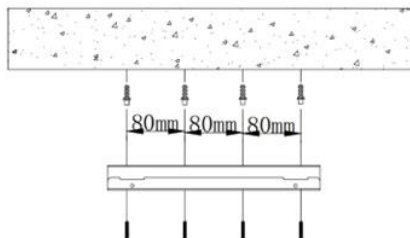
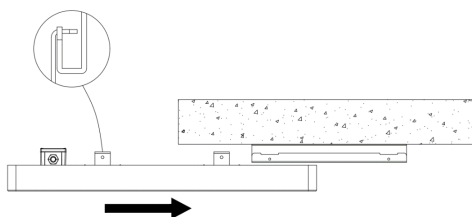

6. Utilice 4 tornillos autorroscantes pequeños para fijar el conjunto del calefactor en el soporte de techo.

